

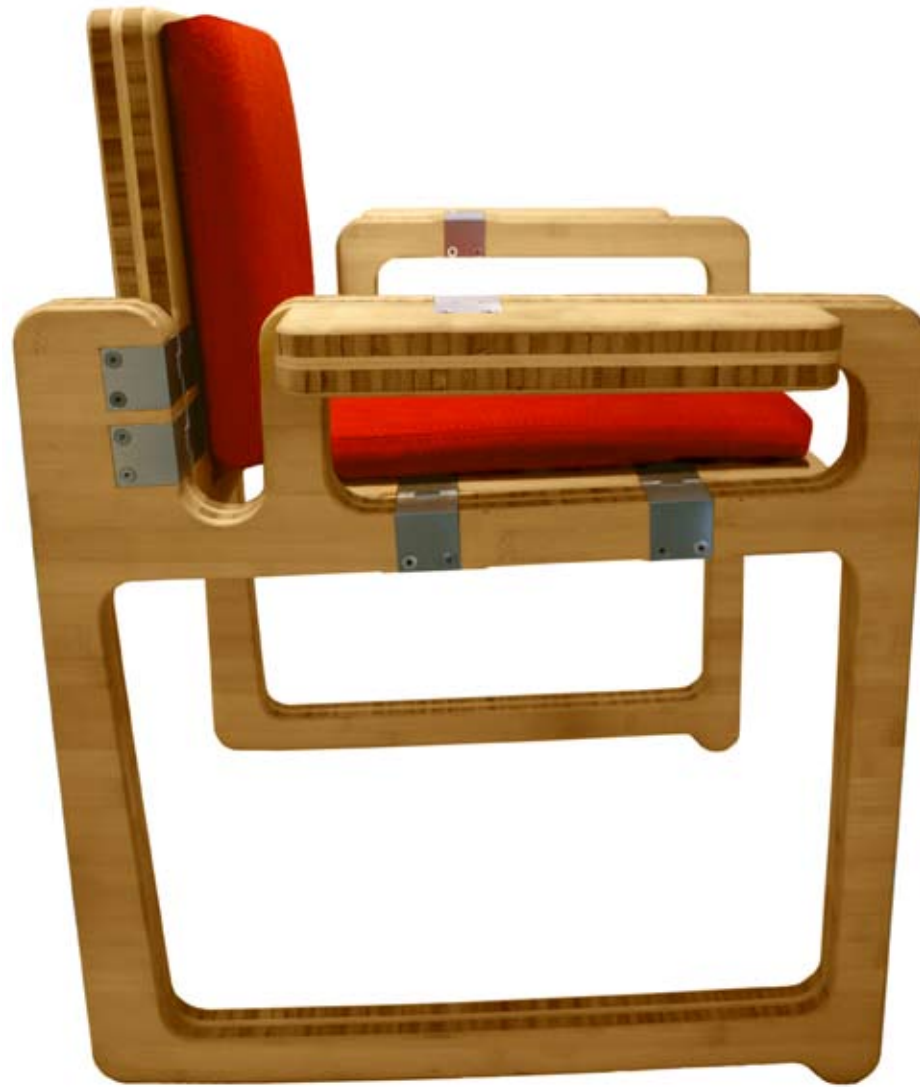

(and mini.)

Alpha Collection



Bamba | *by your side.*



\$2400

Bamba | *by your side.*

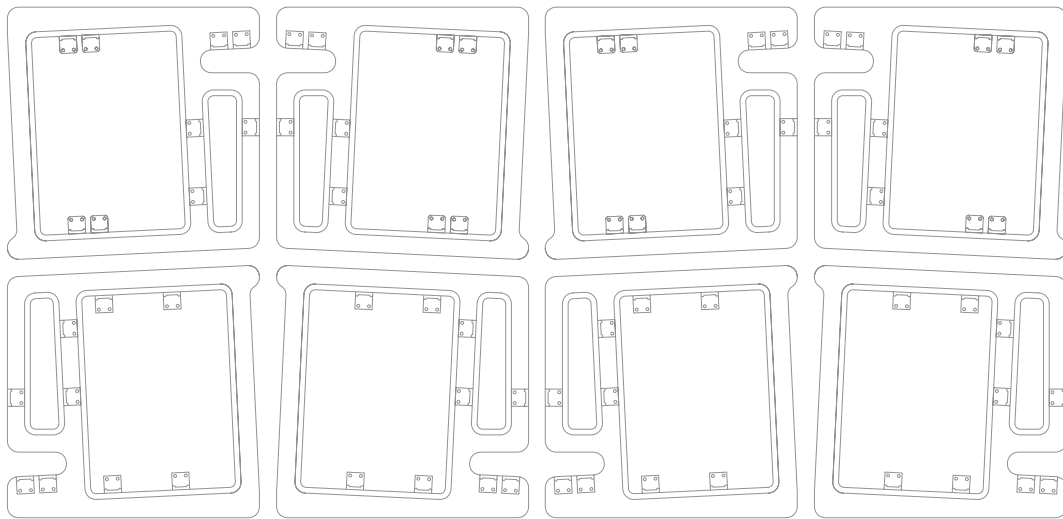

Material efficiency
2 chairs, 1 sheet of wood

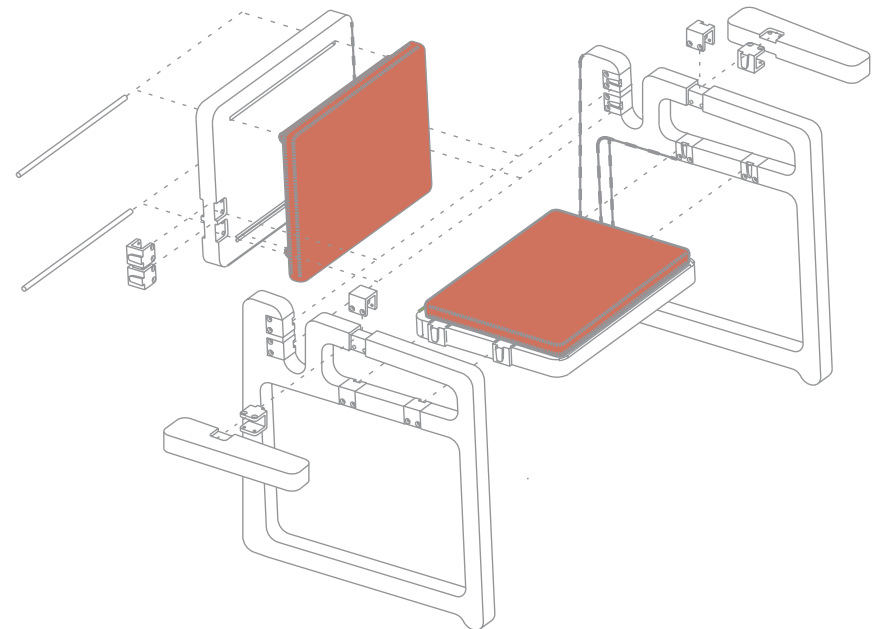

Mechanical assembly
Easy repair

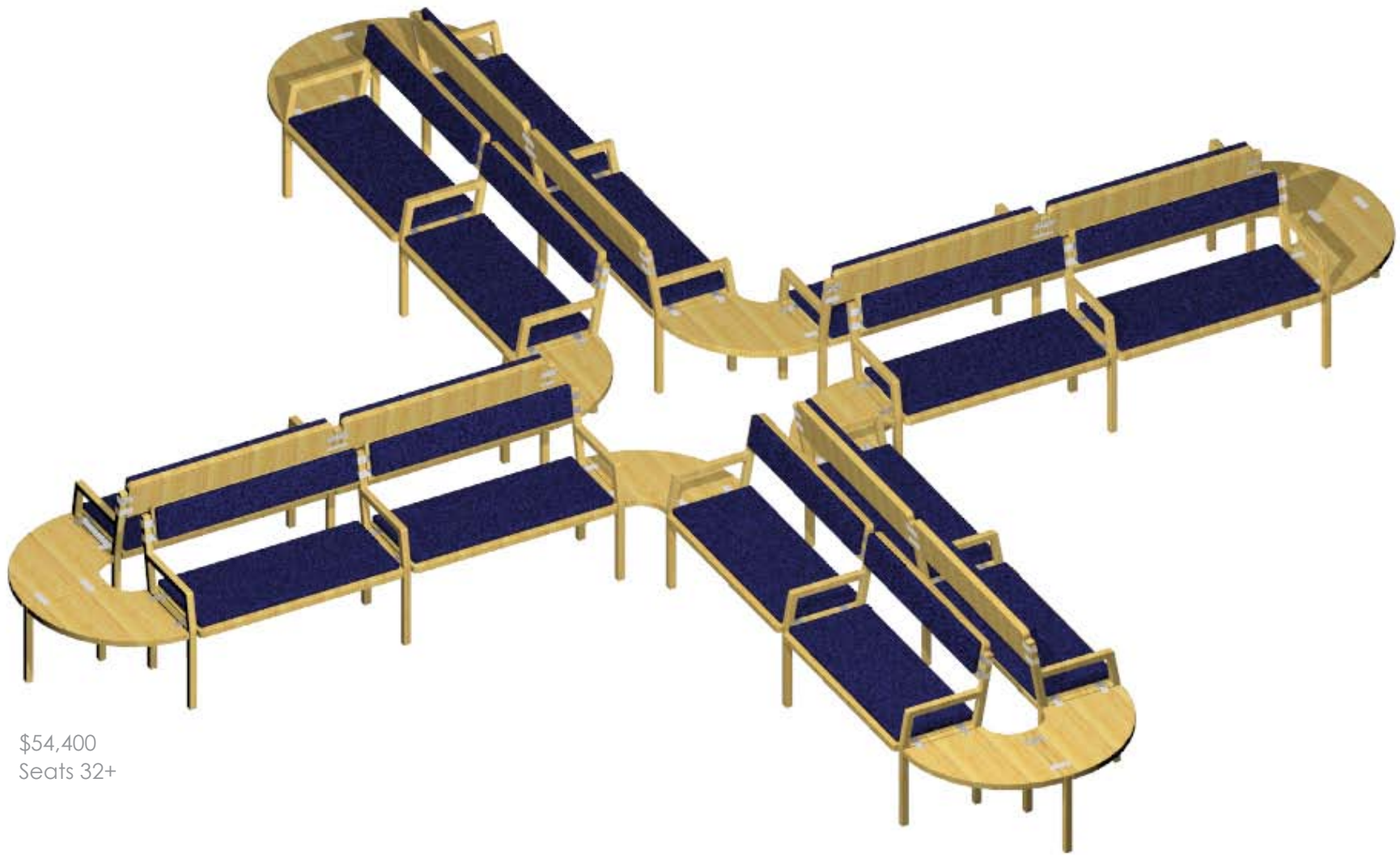

\$54,400
Seats 32+

Tandem 1 | anywhere you wait.



\$8650



\$3650



\$7350

Seats

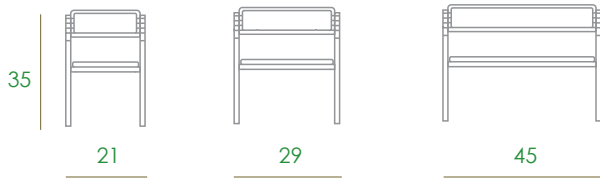

Sides

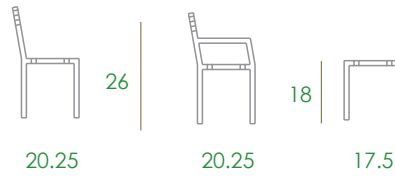

Tables

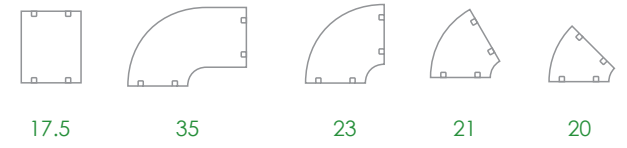

Possibilities

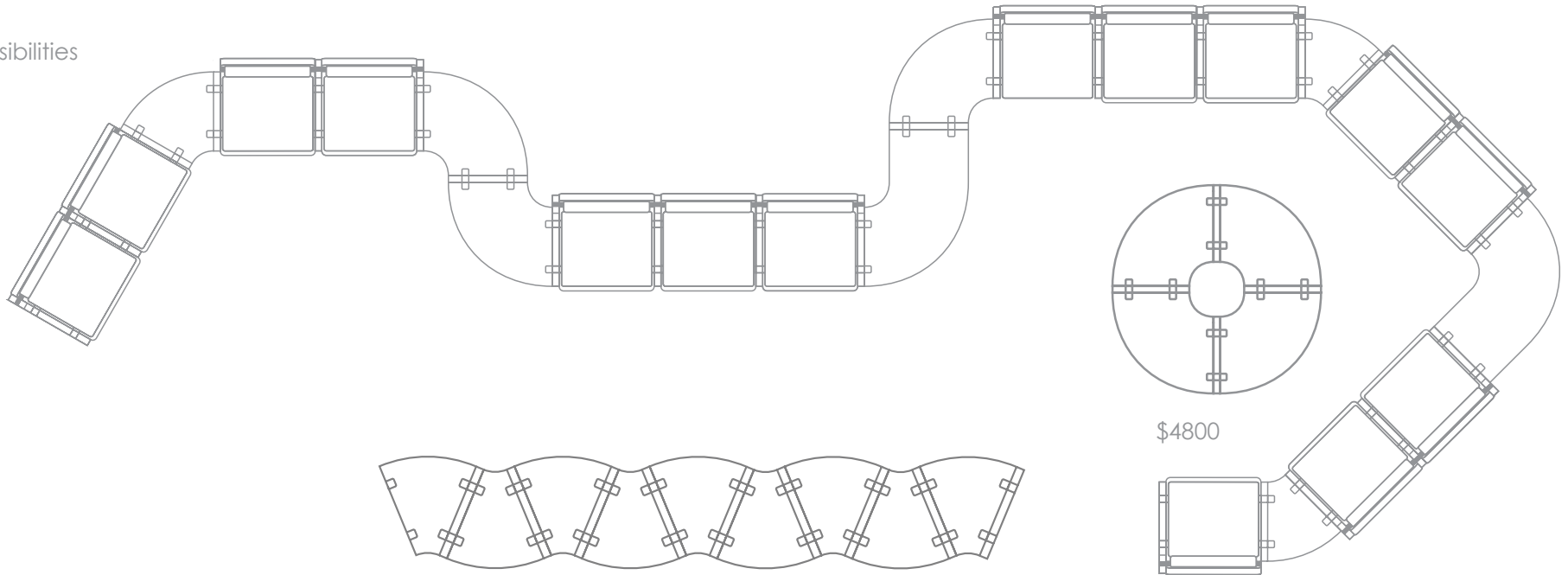

\$10,450

\$4800

\$Call

Tandem 1

anywhere you wait.

Bamboo Plywood



Powerfully reclaims CO2
Rapidly renewable resource
Low VOC
Biodegradable

Wool Fabric*



100% Natural
Biodegradable

Aluminum Hardware



Anodized and sand blasted
Easily recycled

Latex Foam



100% Natural
Biodegradable

Wood Finish

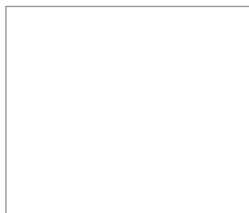

Plant based oils (clear)

Certification Support:

LEED CREDIT**

-Innovation and Design Process 1
Project Specific

-Environmental Quality 4.1 & 4.2
Low-Emitting Materials

-Materials and Resources 5.1 & 5.2
Regional Production

-Materials and Resources 6
Rapidly Renewable Resources

* For fabric selections, COM is possible as long as fabrics are produced sustainably and are biodegradable.

** While no furniture can be LEED certified, the materials and processes we use can contribute to LEED points, especially for commercial interiors.

Bamboo



Natural



Amber

Wool



Copenhagen



Skyblue Light



Burgundy



Creamsicle



Linen

Options

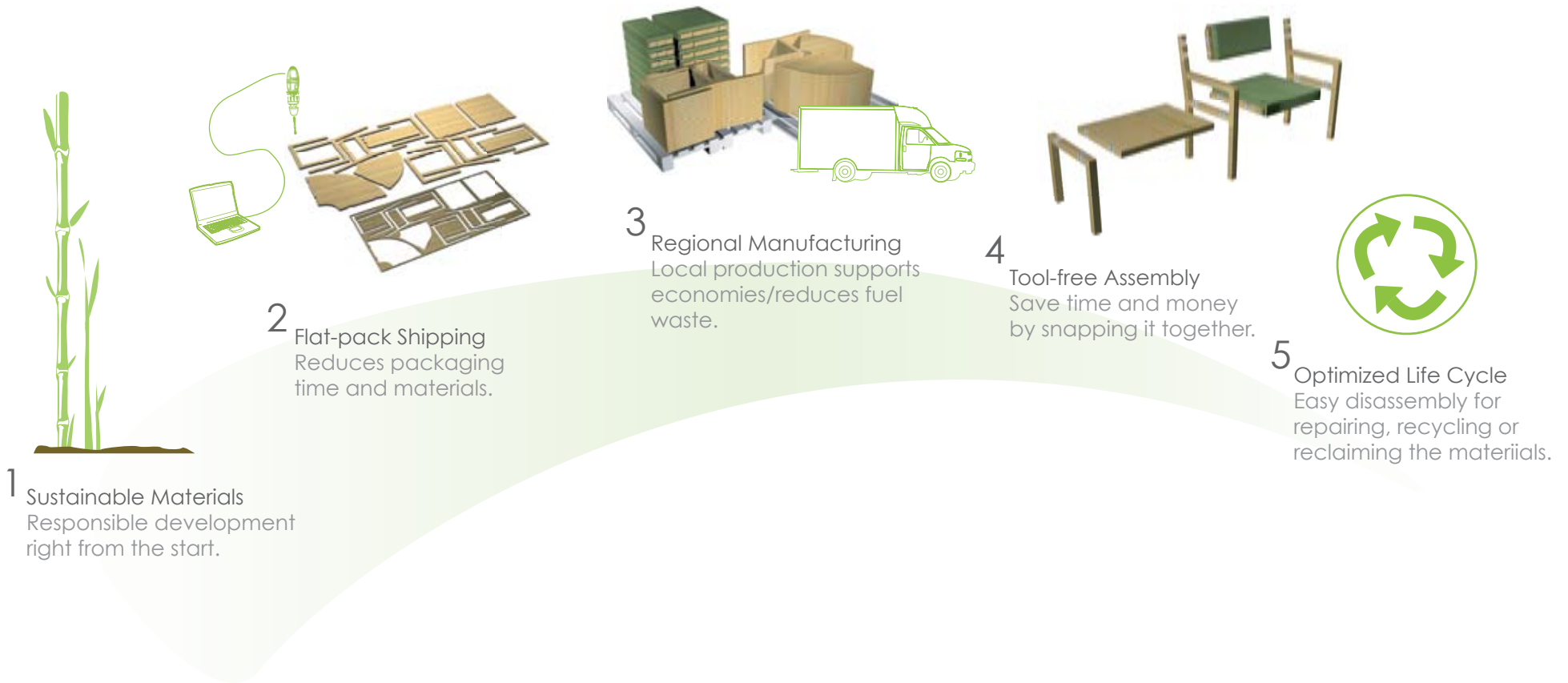

Framework



mini- Bamba

assemble, play, share.

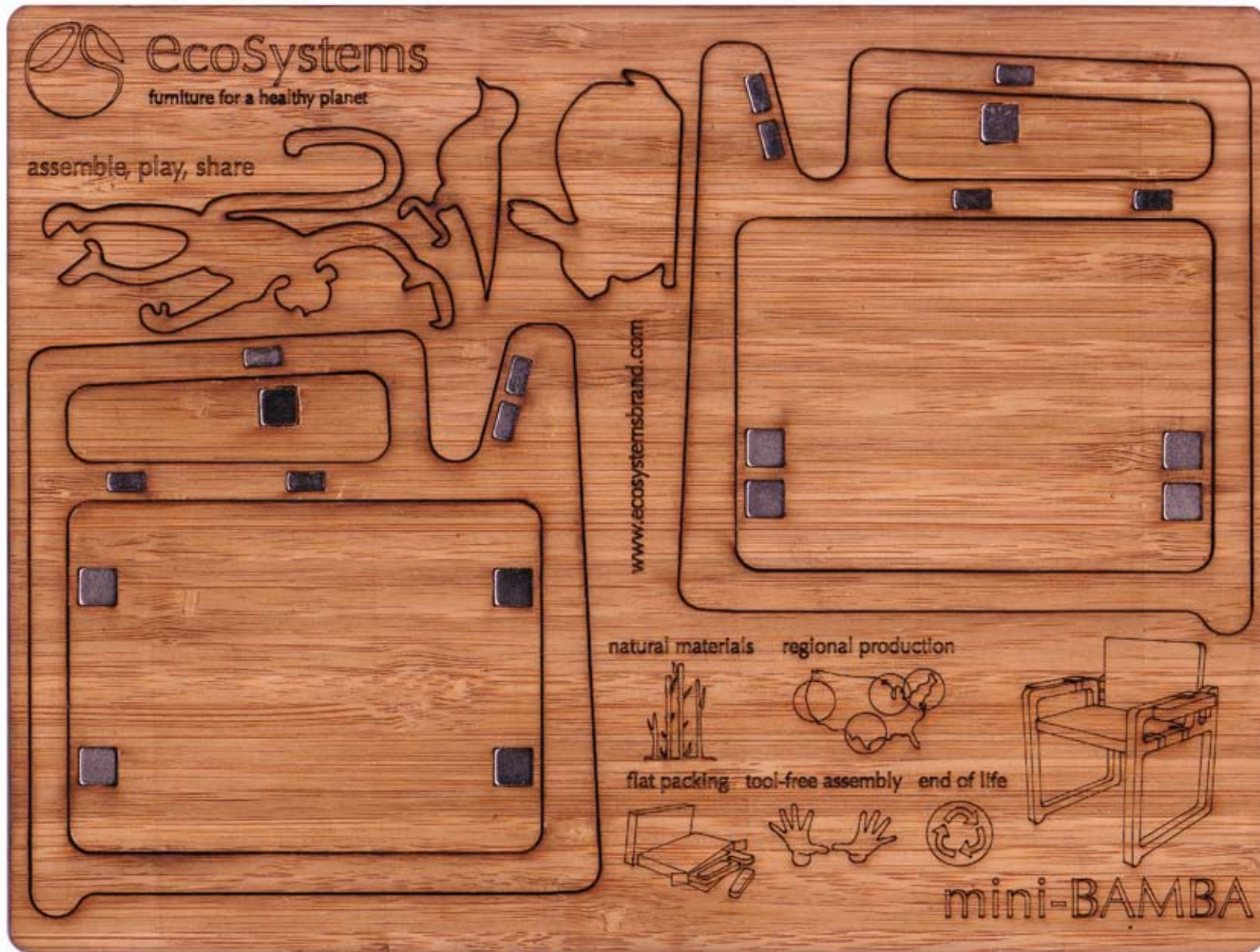

\$125

Actual size

mini- Bamba

assemble, play, share.

Bamba

price

quantity

subtotal

customer ship to:

order date



\$2400

mini- Bamba

Furniture lead time to shipment is approx. 4-6 weeks.
mini-Bamba ships in 1-2 weeks.

customer bill to:

ship date



The mini- Bamba comes with three different animal options. You may choose your set below.

Turtle, Exotic Bird, Squirrel

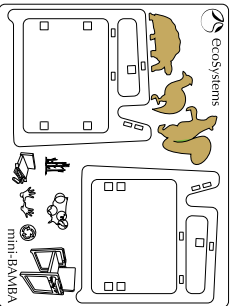

\$125

Monkey, Bird, Rabbit

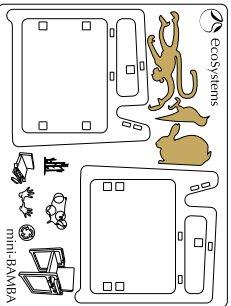

\$125

Snail, Frog, Gecko

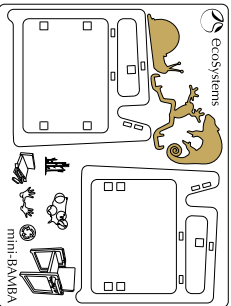

\$125

shipping

wood

finish

fabric

subtotal

extras

tax (NY)

TOTAL



seats

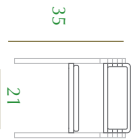

\$1200

price

quantity

subtotal

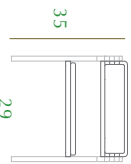

\$1500

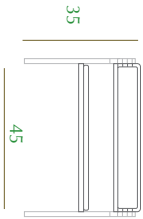

\$1800

sides

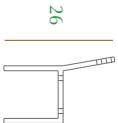

\$600

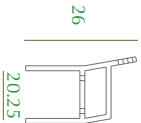

\$650

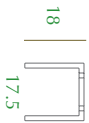

\$550

tables

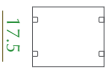

\$650

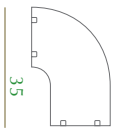

\$750



\$650

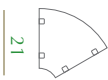

\$600



\$550

customer ship to:

order date

Lead time from order placement to shipment is approx. 4-6 weeks.

customer bill to:

ship date

EcoSystems will review all orders to verify that the parts and quantities will provide complete sets.

wood

finish

fabric

shipping

subtotal

extras

tax (NY)

TOTAL



EcoSystems
design for a healthy planet

Layout - Tandem 1

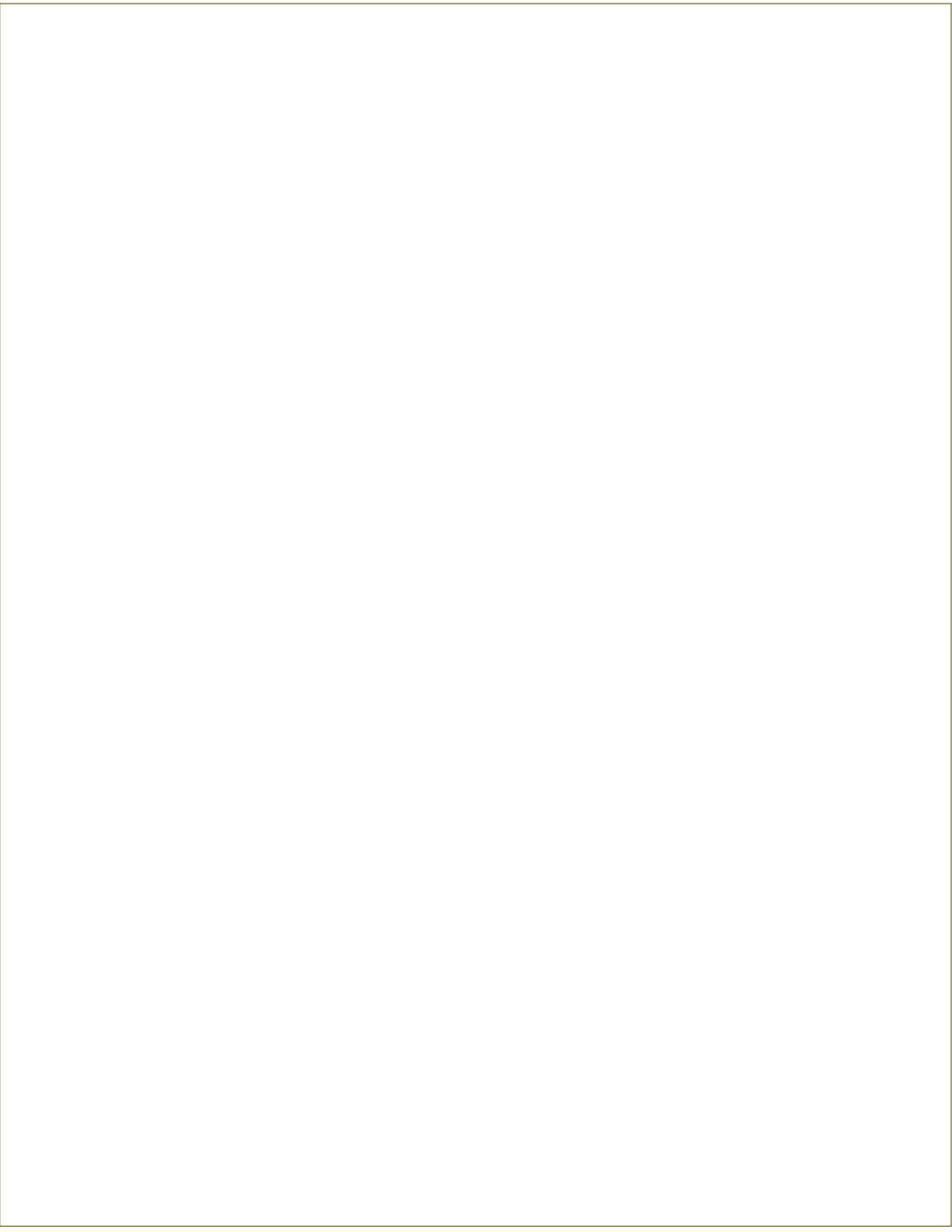

Use this area to illustrate layouts that take advantage of Tandem 1's ability to interconnect (gang) seats and tables around a single side.

Note which sides have arms (A) and which sides have no arms (NA), if they are mixed through out the layout.

Call EcoSystems for assistance with complex layouts or spaces, as well as any custom needs:
718.383.6404

Payment:

Fifty percent (50%) deposit with order, balance due on completion. We reserve the right to cancel any order for which the deposit and C.O.M. have not been received in a timely manner.

Acknowledgments:

An acknowledgment is sent for all orders. Please read it carefully! If there are any discrepancies advise EcoSystems at once as your order will be produced as acknowledged.

Cancellations:

Cancellations will not be accepted on work in progress. Orders cancelled before entering production are subject to a 25% cancellation charge.

Returns:

Merchandise may not be returned without written consent of EcoSystems. Merchandise returned without our consent will be refused and returned to you at your expense.

Regional Production:

Orders of 5 or more pieces will be produced within 500 miles of the final destination, according to LEED standards. Orders of less than 5 chair units will be produced at our Midwest or East Coast locations.

Dimensions:

EcoSystems furniture is using precision computer controlled machines. Finish tolerances are within 0.001" regardless of the manufacturing location.

C.O.M. Information:

The Yardage figures shown on our price list are for 54" plain fabric. For fabrics that require matching, add 10% additional yardage. The C.O.M yardage requirements on match patterns will be determined by both the width of the fabric and the overall repeat. The following chart has been developed so that you are able to determine the amount of additional yardage required:

Fabric Width - 54"

Plain Fabric - 0%
2" - 14" Repeat - 15%
15" - 24" Repeat - 20%
25" - 27" Repeat - 30%
28" - 36" Repeat - 35%

Fabric Width - 50"

Plain Fabric - 10%
2" - 14" Repeat - 25%
15" - 24" Repeat - 35%
25" - 27" Repeat - 40%
28" - 36" Repeat - 45%

Fabric Width - 48"

Plain Fabric - 15%
2" - 14" Repeat - 30%
15" - 24" Repeat - 40%
25" - 27" Repeat - 45%
28" - 36" Repeat - 50%

Fabric Width - 45"

Plain Fabric - 40%
2" - 14" Repeat - 55%
15" - 24" Repeat - 65%
25" - 27" Repeat - 70%
28" - 36" Repeat - 80%

Fabric Width - 38"

Plain Fabric - 55%
2" - 14" Repeat - 65%
15" - 24" Repeat - 75%
25" - 27" Repeat - 85%
28" - 36" Repeat - 100%

When using fabric with unusual designs or repeats that exceed the above, please send a full repeat of the fabric to determine the exact yardage required. EcoSystems reserves the right to reject any C.O.M. that undermines our environmental framework, or that it feels will not upholster in a manner that is representative of our work quality.

Leather:

How to calculate leather from fabric yardage:

For every yard of 36" fabric order 12 square feet.
For every yard of 50" fabric order 17 square feet.
For every yard of 54" fabric order 18 square feet.

C.O.M. Content:

All COM must be 100% natural and biodegradable to work with EcoSystems take back program. Please call EcoSystems for shipping location. Fabric must be clearly sidemarked with your name and/or representative's name, your purchase order number, and the item(s) on which it is to be used and the fabric direction to be applied. We must receive ALL C.O.M. to begin production on your order.

Extra Fabric:

Please send only enough C.O.M. to do the job. EcoSystems WILL NOT BE RESPONSIBLE FOR ANY EXTRA OR LEFT OVER FABRIC.

Freight Quotes:

Quotes are valid on the date quoted but are subject to change at the time of shipment.

Freight Claims:

EcoSystems cannot be responsible for any damage that occurs in transit, concealed or otherwise. Inspect your shipment carefully and if there is any visible damage to either the furniture or carton, note same on the bill of lading before you sign it. YOUR CLAIM IS WITH THE CARRIER AND NOT WITH ECOSYSTEMS.

Cartoning:

If required, there is an additional NET charge of:
\$28.00 - per chair unit
\$35.00 - per bench unit

Storage Charges:

All orders must be picked up or shipped within 14 days of completion or incur storage fees of \$0.50 per cubic foot, per week. (Minimum \$25.00 per week)

Standard Finishes:

All natural oil finish on
Bamboo - Natural
Bamboo - Amber
Palm (Price Doubles for Palm wood)

Custom Finishes:

20% Upcharge (All Natural, LEED Certified Stains)
Maple
Redwood
Mahogany
Birch
Oak
Walnut

Matching Your Color Sample:

Upcharge TBD
Matching will be as close as possible. We CANNOT guarantee an exact match. Please send your sample for a quote.